

Clip-on contact springs are made of copper beryllium (CuBe) with a bright clean surface as standard. CuBe offers excellent electric and thermal conductivity in combination with a high material strength. On request a surface finish like tin-, zinc-, nickel-, silver- or gold-plating can be applied.

The standard program offers a huge variety of contact springs with different mounting methods and dimensions. The contact springs can also be cut to length.

- Different surfaces available
- Custom length available
- Mounting method: clip-on
- Excellent electric and thermal conductivity; high material strength
- Resistance to environmental influences and against corrosion
- High temperature resistance



RoHS



REACH



PRODUCT SPECIFICATIONS

PROPERTY	VALUE / TOLERANCE
Basic material	Copper beryllium (CuBe)
Surfaces	Blank, gold-, silver-, tin-, nickel-, zinc-plated
Density	8,36 g/cm ³
Thermal expansion coefficient	17,5 x 10 ⁻⁶ m/m°C @ -20°C – 200°C
Thermal conductivity	105 W/m*K
Melting point	870 °C
Electrical conductivity	17 – 28 % – IACS*
Operation temperature	-30 -100 °C
Storage humidity	<50 HR

* IACS: International Annealed Copper Standard

Please note: Picture only shows an example of a contact spring.

BUILDING AN ITEM NUMBER

FCB-XXX-YYY-XXF

Contact spring CuBe	
Part number	
BL	Blank
AU	Gold-plated
AG	Silver-plated
SN	Tin-plated
NI	Nickel-plated
ZN	Zinc-plated
xxF	Number of fingers
xxx	Length (in mm)

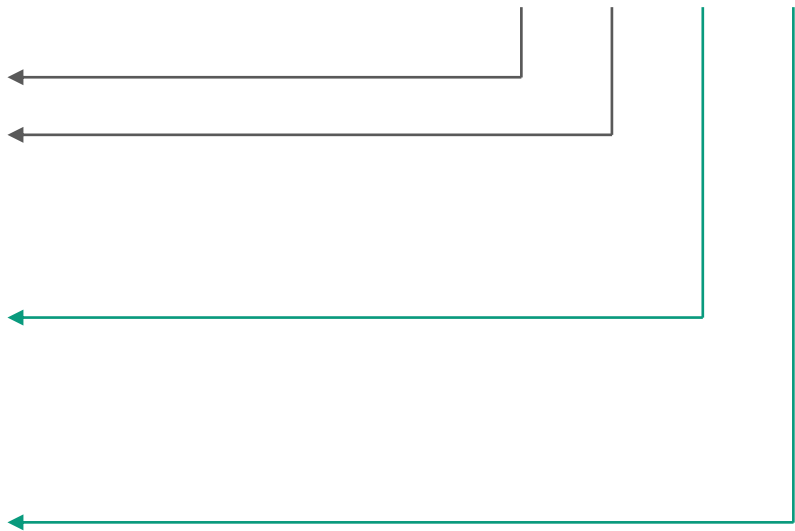

Standard options

EXAMPLE

FCB-152-AU-32F

Contact spring CuBe; contact spring number: 152; gold-plated; length: 32 fingers

DIMENSIONS

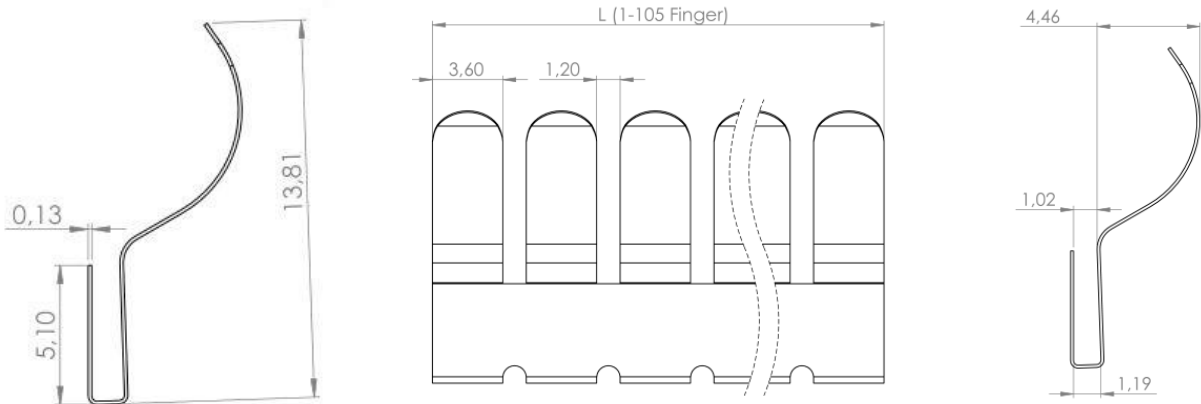

Modifications and errors excepted. The information and statements herein are believed to be reliable but are not to be construed as a warranty or representation for which we assume legal responsibility. Users should undertake sufficient verifications and testings to determine the suitability for their own particular purpose of any information or products referred to herein.