

Stick-on contact springs are made of copper beryllium (CuBe) with a bright clean surface as standard. CuBe offers excellent electric and thermal conductivity in combination with a high material strength. On request a surface finish like tin-, zinc-, nickel-, silver- or gold-plating can be applied.

The standard program offers a huge variety of contact springs with different mounting methods and dimensions. The contact springs can also be cut to length.

- Different surfaces available
- Custom length available
- Mounting method: stick-on (with adhesive tape)
- Excellent electric and thermal conductivity; high material strength
- Resistance to environmental influences and against corrosion
- High temperature resistance



RoHS



REACH



## PRODUCT SPECIFICATIONS

| PROPERTY                      | VALUE / TOLERANCE                                 |
|-------------------------------|---|
| Basic material                | Copper beryllium (CuBe)                           |
| Surfaces                      | Blank, gold-, silver-, tin-, nickel-, zinc-plated |
| Density                       | 8,36 g/cm <sup>3</sup>                            |
| Thermal expansion coefficient | 17,5 x 10 <sup>-6</sup> m/m°C @ -20°C – 200°C     |
| Thermal conductivity          | 105 W/m*K   |
| Melting point                 | 870 °C  |
| Electrical conductivity       | 17 – 28 % – IACS*                                 |
| Operation temperature         | -30 -100 °C                                       |
| Storage humidity              | <50 HR  |

\* IACS: International Annealed Copper Standard

Please note: Picture only shows an example of a contact spring.

### BUILDING AN ITEM NUMBER

**FCB-XXX-YYY-L**

|                     |                   |
|---------------------|-------------------|
| Contact spring CuBe |                   |
| Part number         |                   |
| BL                  | Blank             |
| AU                  | Gold-plated       |
| AG                  | Silver-plated     |
| SN                  | Tin-plated        |
| NI                  | Nickel-plated     |
| ZN                  | Zinc-plated       |
| xxx                 | Length (in mm)    |
| xxxF                | Number of fingers |

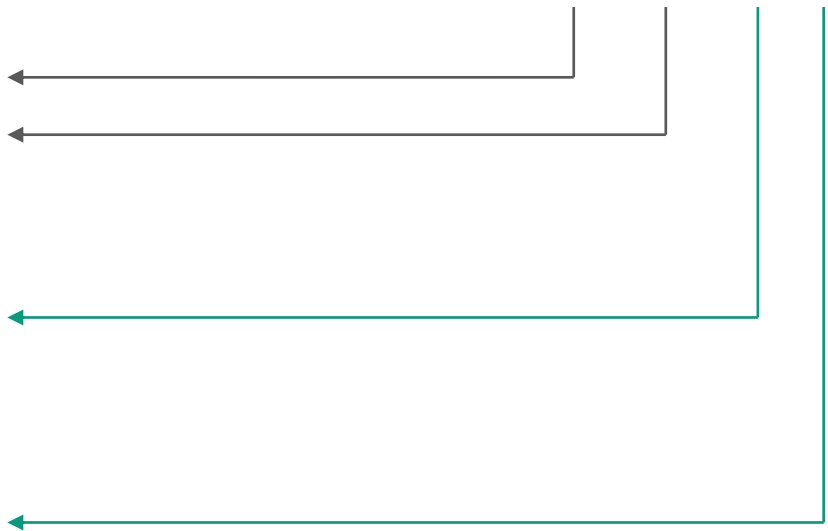

### Standard options

**EXAMPLE**

**FCB-422-AU-406**

Contact spring CuBe; contact spring number: 422; gold-plated; length: 406 mm

### DIMENSIONS

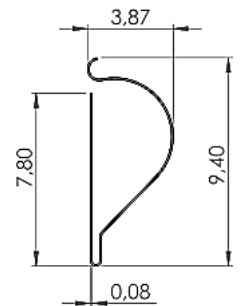
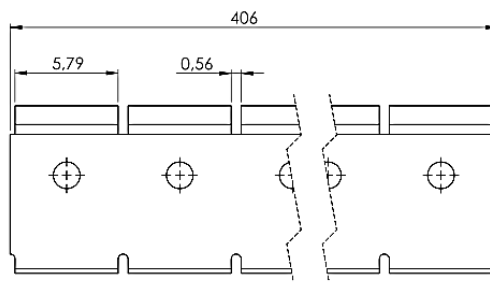
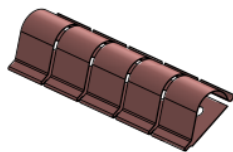

Modifications and errors excepted. The information and statements herein are believed to be reliable but are not to be construed as a warranty or representation for which we assume legal responsibility. Users should undertake sufficient verifications and testings to determine the suitability for their own particular purpose of any information or products referred to herein.