

Coextruded elastomere profiles consist of a conductive and a non-conductive component. They are produced in a single extrusion process and offer very good EMC shielding properties as well as high protection against environmental influences.

Coextruded elastomers are produced according to customer requirements. Various shapes are available. Fluorsilicone can also be used for applications with oil or fuels.

- Combi-gasket for EMC and environmental protection
- Highest environmental protection (up to IP68) of the non-conductive area
- Use of Fluorsilicone if material should be resistant against aggressive substances
- Cost-effective solution compared to two separate gaskets
- Customer-specific manufacturing
- Halogen-free

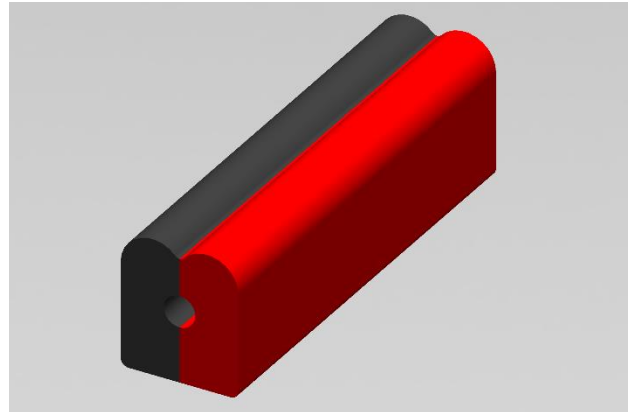

PRODUCT SPECIFICATIONS

PROPERTY	VALUE / TOLERANCE		TEST METHOD
Basic rubber material (non-conductive)	Silicone	Fluorsilicone	-
Hardness	50 ± 3 Shore A	70 ± 5 Shore A	ASTM D2240
Density	1,14 ± 0,03 g/cm ³	1,43 ± 0,2 g/cm ³	ASTM D792
Tensile strenght	7,5 MPa	Min. 9 MPa	ASTM D412
Elongation at break (min)	450 %	Min. 200 %	ASTM D412
Tear strenght	16 kN/m	Min. 16 kN/m	ASTM D624
Operating temperature	-60 – 250 °C	-55 – 200 °C	ASTM D1392
Flammability rating	HB	HB	UL94
Halogen-free	Yes	Yes	-

TOLERANCES

CROSS SECTION (mm)	TOLERANCE (mm)	CUT LENGTH (mm)	TOLERANCE (mm)
≤ 1,57	± 0,13	≤ 25,4	± 0,50
1,57 - 9,0	± 0,20	25,4 - 400	± 1
9,0 - 12,7	± 0,25	> 400	± 0,2%
> 12,7	± 3%		

DIMENSIONS (mm)

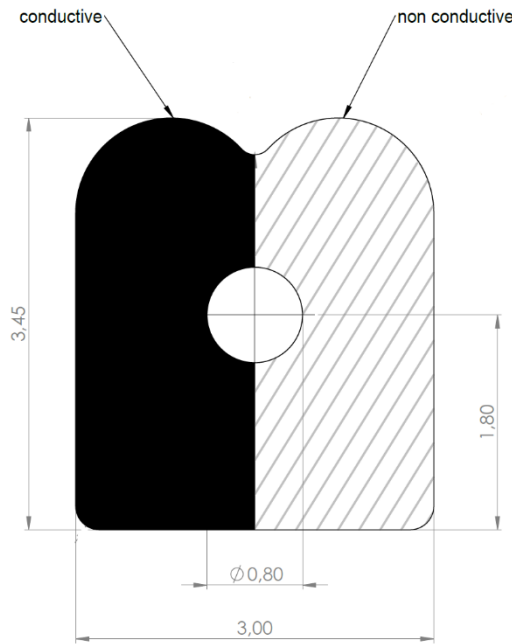

BUILDING AN ITEM NUMBER

XXX-3,00x3,45-YYYY

SCE	Silicone coextruded
FSCE	Fluorsilicone coextruded

3,00	Width (mm)
------	------------

3,45	Height (mm)
------	-------------

AGAL	Silver plated Aluminum
AGCU	Silver plated Copper
AGGL	Silver plated Glass*
NIC	Nickel plated Graphite

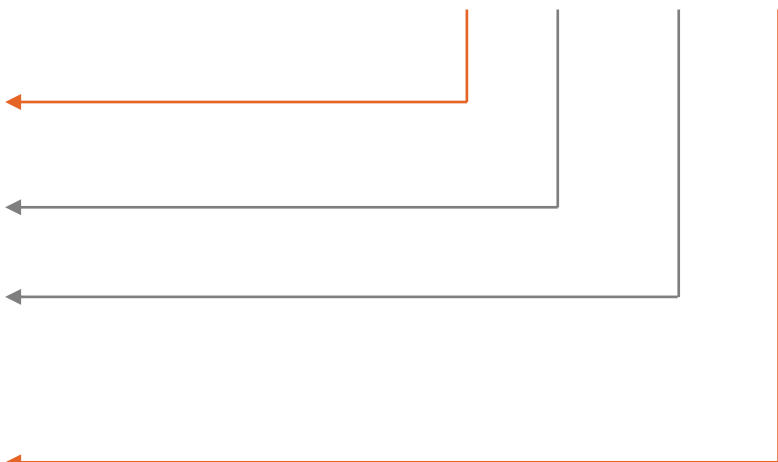

* Combination of AGGL and Fluorsilicone is not possible

EXAMPLE

SCE-3,00x3,45-AGCU

Silicone coextruded; width: 3,00mm; height: 3,45mm; Filler Material: Silver plated Copper